



The following page(s) are extracted from multi-page Kuhnke product catalogues or CDROMs and any page number shown is relevant to the original document. The PDF sheets here may have been combined to provide technical information about the specific product(s) you have selected.

Hard copy product catalogues, and CDROMs have been published describing Kuhnke Pneumatics, Solenoids, Relays and Electronics; some divided into different books. A list of current publications is available on this web site or from our sales offices. Some may be available for download, but as substantially larger files.

Contact Details

Kuhnke sales and service in North America

Ellis/Kuhnke Controls
132 Lewis Street
Unit A-2, Eatontown
NJ 07724
USA

T: (800) 221 0714
T: (732) 291 3334
F: (732) 291 8154

Important Note

The information shown in these documents is for guidance only. No liability is accepted for any errors or omissions. The designer or user is solely responsible for the safe and proper application of the parts, assemblies or equipment described.

Zylinder CNOMO-Zylinder

Doppeltwirkend, mit/ohne Magnetkolben
Ø 32 - 200 mm

Technische Daten:

Betriebsdruck: 0,5 - 10 bar
Umgebungs-
temperatur: - 25 °C...+80 °C

Werkstoffe:

Zylinderrohr: Profilrohr aus eloxierter
Aluminiumlegierung,
15 µm kalibriert
Zylinderdeckel: Aluminiumdruckguss
Kolbenstange: verchromter Stahl
Dichtungen: NBR
Schmiermittel: nicht erforderlich
Medium: Druckluft, gewartet*

Hubbegrenzung: möglichst extern
(optimale Lebensdauer)

Hubtoleranz:

Ø 32- 50 < 500 mm: +2,0 mm
> 500 mm: +3,2 mm
Ø 63-100 < 500 mm: +2,5 mm
> 500 mm: +4,0 mm
Ø 125-200 < 500 mm: +4,0 mm
> 500 mm: +5,0 mm

Befestigung: Durch Innengewinde-
boden und deckel-
seitig**

Sonderzylinder nach ihren Angaben und
Zylinder mit doppelseitiger Kolbenstange
sowie Zylinder mit Zwischen- und Über-
längen bitten wir anzufragen.

Länge der Dämpfung

Ø Zylinder	Länge der Dämpfung CNOMO-Zylinder (mm)
32	20
40	22
50	26
63	30
80	32
100	34
125	34
160	30
200	30

* Siehe Technische Information
** Siehe Zubehör für CNOMO-Zylinder

Cylinders CNOMO Cylinders

Double Acting, with/without Magnetic Piston
Diameter 32 - 200 mm

Technical Data:

Operating
pressure: 0.5 - 10 bar
Ambient tem-
perature range: - 25 °C...+80 °C
Materials:

Cylindertube: anodised
aluminium, 15 µm
drawn and calibrated
Cylinder covers: die-cast aluminium
Piston rod: chromed plated steel
Seals: NBR
Lubricant: not required
Operating
medium: compressed air,
prepared*

Stroke
limitation: if possible external
(for optimum life)

Stroke

tolerance:
Ø 32- 50 < 500 mm: +2.0 mm
> 500 mm: +3.2 mm
Ø 63-100 < 500 mm: +2.5 mm
> 500 mm: +4.0 mm
Ø 125-200 < 500 mm: +4.0 mm
> 500 mm: +5.0 mm

Mounting: through top-sided and
bottom-sided female
threads**

Please enquire about special cylinders to
your own requirements and cylinders
with double-sided piston rod as well as
intermediate and extra long dimensions.

Length of the cushions

Ø Cylinder	Length of the cushions CNOMO cylinders (mm)
32	20
40	22
50	26
63	30
80	32
100	34
125	34
160	30
200	30

* See Technical Information
** See Accessories for CNOMO cylinders

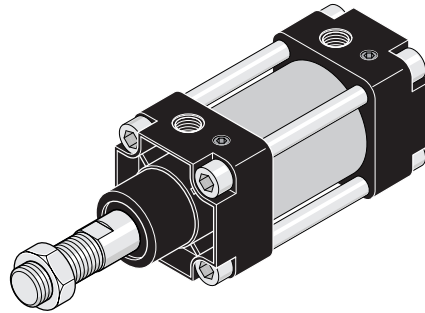

Zylinder CNOMO-Zylinder

Doppeltwirkend, mit/ohne Magnetkolben
Ø 32 - 200 mm

Cylinders CNOMO Cylinders

Double Acting, with/without Magnetic Piston
Diameter 32 - 200 mm

Statische Zylinderkennlinien* Kolbendurchmesser

Static Cylinder Characteristics* Piston Diameter

Ø 32 mm

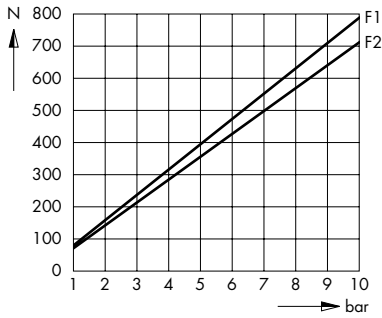

Ø 63 mm

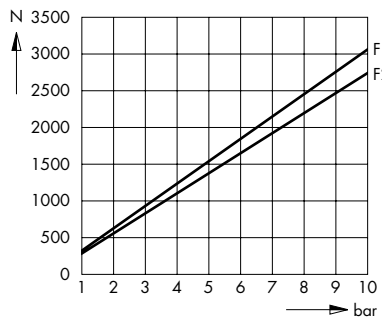

Ø 125 mm

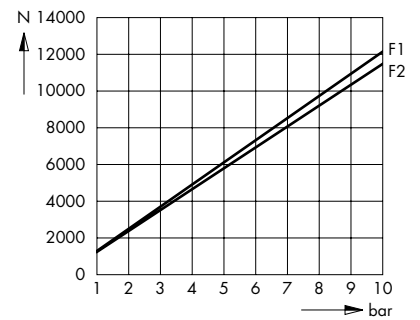

Ø 40 mm

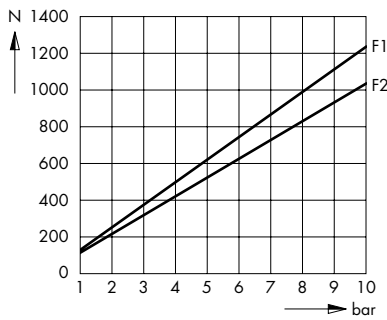

Ø 80 mm

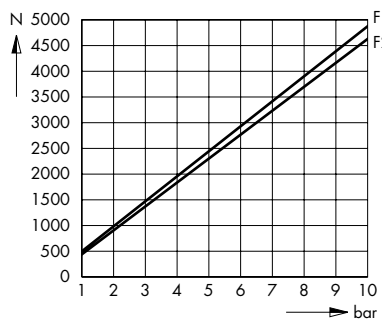

Ø 160 mm

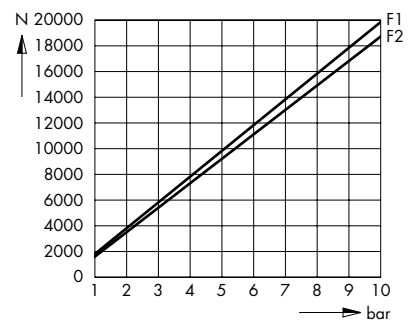

Ø 50 mm

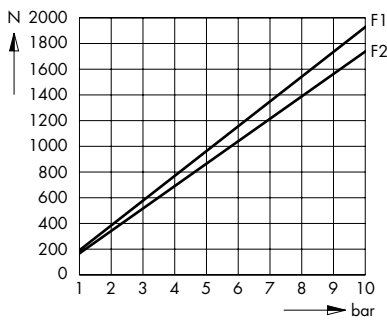

Ø 100 mm

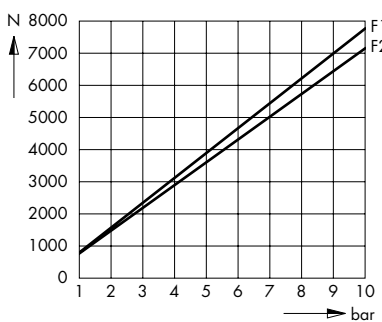

Ø 200 mm

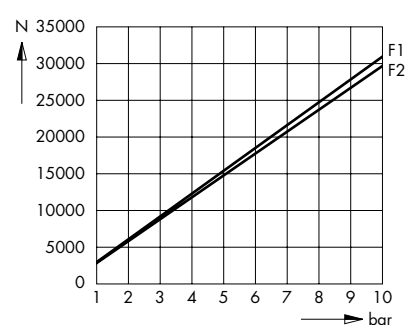

* Für das dynamische Verhalten sind die Zylinderkennlinien mit dem Faktor 0,5 - 0,7 zu multiplizieren.

F1 = doppeltwirkende Zylinder im Vorlauf
F2 = doppeltwirkende Zylinder im Rücklauf

* The cylinder characteristics are to be multiplied by a factor of 0.5 - 0.7 for the dynamic behaviour.

F1 = double acting cylinders in forward stroke
F2 = double acting cylinders in return stroke

Zylinder CNOMO-Zylinder

Doppeltwirkend, mit/ohne Magnetkolben
Ø 32 - 200 mm

Cylinders CNOMO Cylinders

Double Acting, with/without Magnetic Piston
Diameter 32 - 200 mm

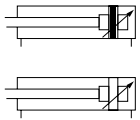

mit Magnet

ohne Magnet



with magnet

without magnet

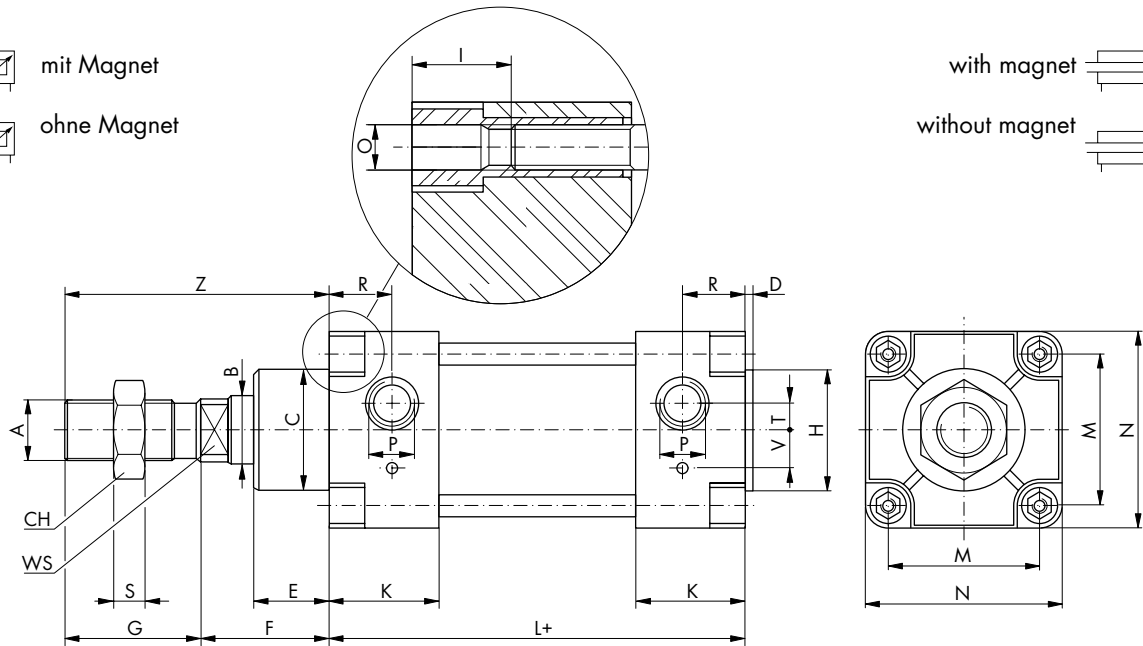

Maßtabelle

Dimensions

Kolben Ø Piston dia. mm	A	B	CØ	CH	D	E	F	G	H	I	K	L+	M	N	O	P	R	S	T	V	WS	Z
32	M10 x 1,5	12	25	17	2	15	25	20	25	10	26	80	33	45	M6	G1/8	15,5	6	6	7	10	45
40	M16 x 1,5	18	32	24	2	20	34	36	32	10	29	110	40	52	M6	G1/4	16,5	8	5	10	16	70
50	M16 x 1,5	18	32	24	3	20	34	36	32	10	29	110	49	65	M8	G1/4	16,5	8	5	10	16	70
63	M20 x 1,5	22	45	30	3	20	39	46	45	10	34	125	59	75	M8	G3/8	18,5	9	7	14	20	85
80	M20 x 1,5	22	45	30	4	20	39	46	45	15	35	125	75	95	M10	G3/8	20	9	9	14	20	85
100	M27 x 2	30	55	41	4	27	47	63	55	15	38,5	145	90	115	M10	G1/2	21	12	14	14	27	110
125	M27 x 2	30	55	41	5,5	25	47	63	55	20	38,5	145	110	140	M12	G1/2	22,5	12	0	20	27	110
160	M36 x 2	40	65	55	7	25	50	85	65	25	41,5	180	140	180	M16	G3/4	22,5	14	0	21	32	135
200	M36 X 2	40	65	55	7	25	50	85	65	25	41,5	180	175	220	M16	G3/4	23	14	0	21	32	135

Standardhöhe:

25/40/50/75/80/100/125/150/160/
175/200/250/300/350/400/450 (mm)

Strokes:

25/40/50/75/80/100/125/150/160/
175/200/250/300/350/400/450 (mm)

Bestellformel:

16.100.0200

- Hubangabe _____
- Kolbenausführung _____
- 2 = mit Magnetkolben
- 0 = ohne Magnetkolben
- Version _____
- 0 = Standard
- 1 = Kolbenstange durchgehend
- 2 = Tandem
- 3 = doppelseitige Kolbenstange
- 4 = Kolbenstange rostfrei
- 8 = Vitondichtungen
- Kolbendurchmesser _____
- 1 = Ø 32
- 2 = Ø 40
- 3 = Ø 50
- 4 = Ø 63
- 5 = Ø 80
- 6 = Ø 100
- 7 = Ø 125
- 8 = Ø 160
- 9 = Ø 200
- Geräte Kennziffer _____

Ordercode:

16.100.0200

- Stroke _____
- Piston version _____
- 2 = with magnetic piston
- 0 = without magnetic piston
- Version _____
- 0 = standard
- 1 = through rod
- 2 = Tandem
- 3 = back to back
- 4 = stainless piston rod
- 8 = Viton seals
- Piston diameter _____
- 1 = Ø 32
- 2 = Ø 40
- 3 = Ø 50
- 4 = Ø 63
- 5 = Ø 80
- 6 = Ø 100
- 7 = Ø 125
- 8 = Ø 160
- 9 = Ø 200
- Type No. _____

Schwenklager mit Bolzen

Female swivel bearing with bolt

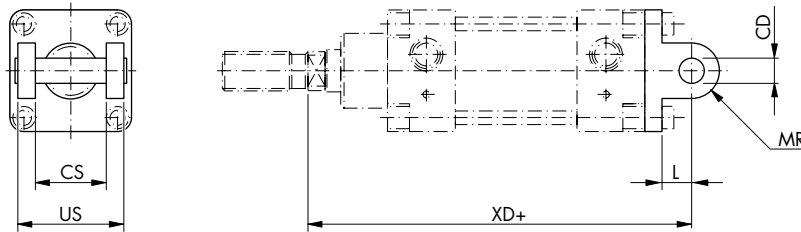

Bestell-Nr./Order No.	Ø	CS	UB	L	XD	CD	MR
16.001.01	32	26	45	10	123	8	9
16.001.02	40	33	52	16	168	12	12
16.001.03	50	33	60	16	170	12	12
16.001.04	63	47	70	20	194	16	17
16.001.05	80	47	90	20	196	16	17
16.001.06	100	57	110	25	229	20	21
16.001.07	125	57	140	30	233	25	24
16.001.08	160	72	170	35	285	25	30
16.001.09	200	72	170	35	285	25	30

Montageflansch für Schwenklager
 mit Bolzen

Mounting flange for female clevis

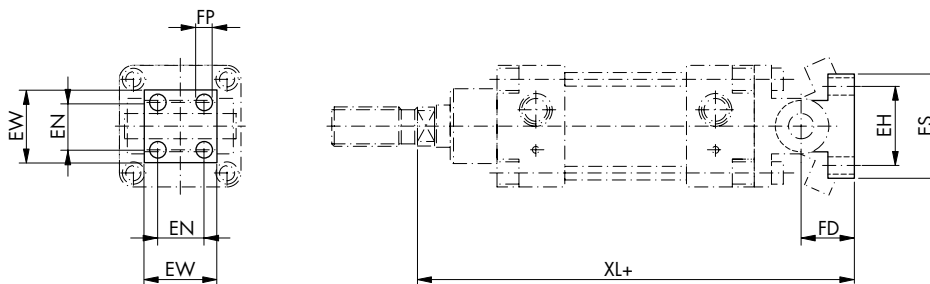

Bestell-Nr./Order No.	Ø	LG	EN	EW	XL	FD	EH	ES	E
16.003.01	32	7		25	141	18	28	40	8
16.003.02	40	9	16	32	194	26	38	52	10
	50	9	16	32	196	26	38	52	10
16.003.04	63	11	25	46	228	34	54	75	12
	80	11	25	46	230	34	54	75	12
16.003.06	100	14	32	56	270	41	90	115	16
	125	14	32	56	274	41	90	115	16
16.003.08	160	18	43	71	340	55	150	180	20
	200	18	43	71	340	55	150	180	20

Montagewinkel
(1 Stück)

Mounting bracket
(1 piece)

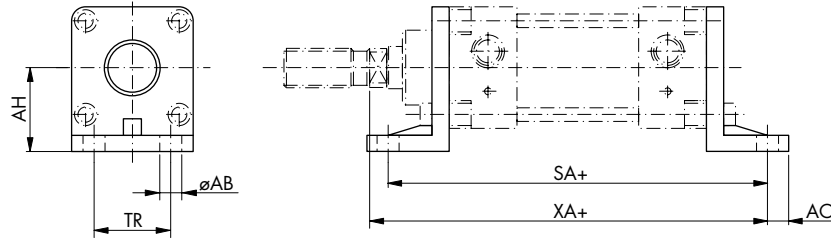

Bestell-Nr./Order No.	∅	AH	TR	AB	SA	XA	AO
16.005.01	32	32	28	7	134	132	8
16.005.02	40	36	36	7	164	171	8
16.005.03	50	45	45	9	180	179	8
16.005.04	63	50	55	9	195	199	10
16.005.05	80	63	70	11	211	207	12
16.005.06	100	73	90	11	231	235	12
16.005.07	125	90	100	14	249	244	16
16.005.08	160	115	130	18	304	292	18
16.005.09	200	135	170	18	304	292	28

Mittelschwenklager einstellbar*

Adjustable centered swivel bearing*

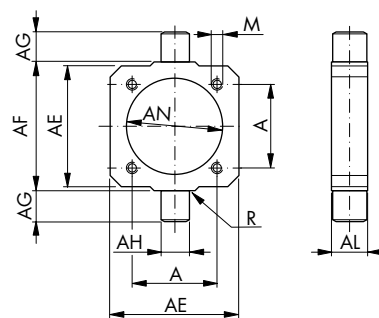

Bestell-Nr./Order No.	∅	A	AE	AL	AH	AG	AF	AN	R	M
16.017.01	32	33	46	15	12	12	50	37	1	M6
16.017.02	40	40	59	20	16	16	63	46	1,5	M6
16.017.03	50	49	69	20	16	16	75	56	1,6	M8
16.017.04	63	59	84	25	20	20	90	69	1,6	M8
16.017.05	80	75	102	25	20	20	110	87	1,6	M10
16.017.06	100	90	125	30	25	25	132	107	2	M10
16.017.07	125	110	155	32	25	25	160	133	2	M12
16.007.08	160	140	190	40	32	32	200	170	2,5	M16
16.007.09	200	175	240	40	32	32	250	211	2,5	M16

* ∅ 160 und 200 sind nur für feste Montageposition lieferbar

* d 160 and d 200 are supplied in not adjustable version only

Montageflansch 90° für Schwenklager
 mit Bolzen

Mounting flange 90° for female clevis

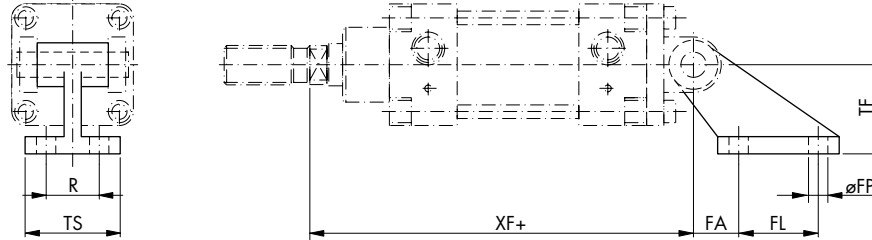

Bestell-Nr./Order No.	Ø	R	TS	FP	XF	FA	FL	TF
16.004.01	32	25	41	7	123	18	20	32
16.004.02	40	32	52	9	168	25	32	45
	50	32	52	9	170	25	32	45
16.004.04	63	40	63	11	194	32	50	63
	80	40	63	11	196	32	50	63
16.004.06	100	50	80	14	229	40	70	90
	125	50	80	14	233	40	70	90
16.004.08	160	63	110	18	285	50	110	140
	200	63	110	18	285	50	110	140

Gabelkopf

Clevis

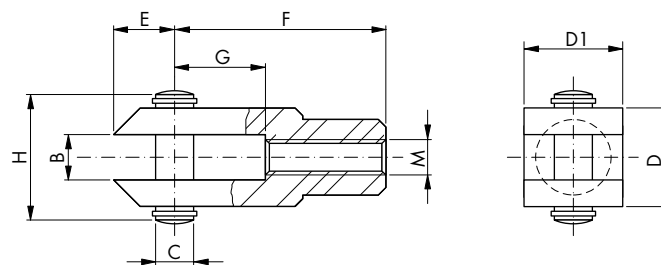

Bestell-Nr./Order No.	Ø	M	B	C	D	E	F	G	H
16.008.01	32	M10 X 1,5	11	8	22/22	9	36	16	30
16.008.02	40/50	M16 X 1,5	18	12	36/26	13	51	25	45
16.008.03	63/80	M20 X 1,5	22	16	45/34	17	63	33	55
16.008.04	100/125	M27 X 2	30	20	63/42	20	85	40	75
16.008.05	160/200	M36 X 2	40	25	80/50	25	115	40	95

Flanschplatte

Mounting plate

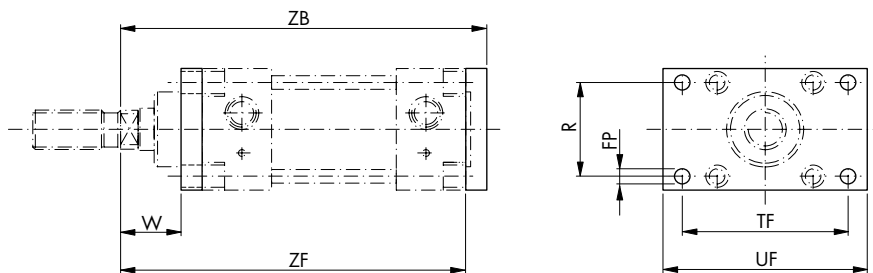

Bestell-Nr./Order No.	Ø	W	ZB	R	FP	TF	UF
16.006.01	32	17	113	33	9	68	80
16.006.02	40	26	152	40	9	78	90
16.006.03	50	24	154	49	11	94	110
16.006.04	63	29	174	59	11	104	120
16.006.05	80	27	176	75	14	130	150
16.006.06	100	39	204	90	14	150	170
16.006.07	125	31	208	110	18	180	205
16.006.08	160	30	250	140	22	228	260
16.006.09	200	30	250	175	22	268	300

Schwenklager

Male swivel bearing

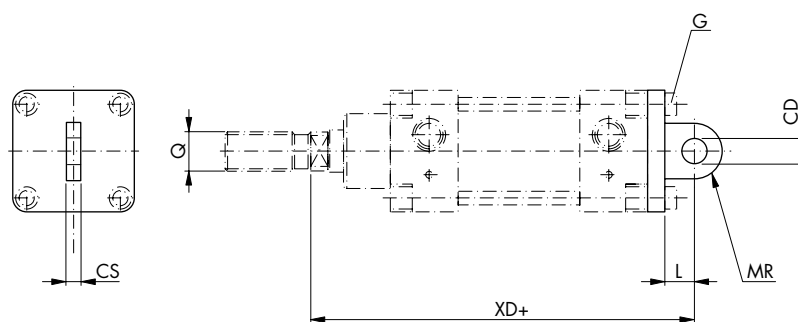

Bestell-Nr./Order No.	Ø	CB	L	XD	CD	MR	ZF
16.002.01	32	26	12	142	10	11	105
16.002.02	40	28	15	160	12	13	144
16.002.03	50	32	15	170	12	13	144
16.002.04	63	40	20	190	16	17	164
16.002.05	80	50	20	210	16	17	164
16.002.06	100	60	25	230	20	21	192
16.002.07	125	70	30	275	25	26	192
16.002.08	160	90	35	315	30	31	230
16.002.09	200	90	35	335	30	31	230

Gelenkkopf

Ball ended clevis

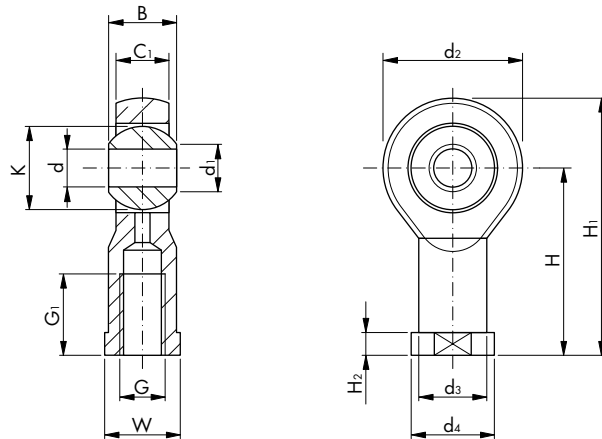

	Ø	G	dH7	B	C1	d1	d2	d3	d4	H	H1	H2	G1	K	W
Bestell-Nr./Order No.		E		V	L	Y	D	B	A	X	U	Z	P	J	CH
16.009.01	32	M10 X 1,5	10	14	10,5	10	28	15	19,5	43	57	6,5	20	19	17
16.009.02	40-50	M16 X 1,5	16	21	15	16	32	22	27	64	85	8	28	28,6	19
16.009.03	63-80	M20 X 1,5	20	25	18	20	42	27,5	34	77	102	10	33	35	22
16.009.04	100-125	M27 X 2	30	37	25	30	50	40	50	110	145	15	51	50,8	30
16.009.05	160-200	M36 X 2	35	43	28	35	70	46	58	125	165	17	56	57,1	41

Zylinder
CNOMO-Zylinder
Zubehör
Positionsgeber mit Reed-Sensor

Cylinders
CNOMO Cylinders
Accessories

Position Transmitter with REED Sensor

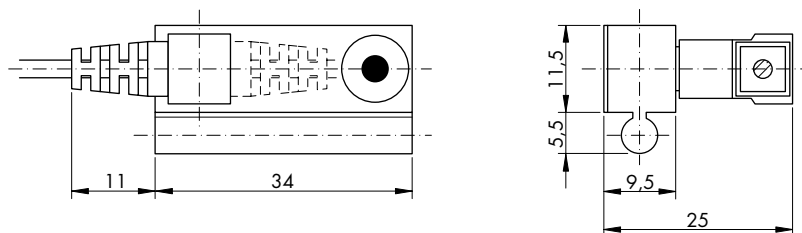

Bestell-Nr.	33.18.115
Schaltbild	

Order No.	33.18.115
Circuit diagram	

Eigenschaften			Features
Betriebstemperatur	-20 +50	°C	Operating temperature
Schutzart	IP 67		Protection class
Kabel Länge – Querschnitt	3000/0,35	mm/mm ²	Cable length – section
Max. Spannung	* 110/220	V _≅	Max. voltage
Max. Schaltstrom bei 25° C (Widerstandslast)	0,5	A	Max. switching current at 25 °C (resistive load)
Schalteleistung	10	W/VA	Switching capacity
Reproduzierbarkeit	± 0,02	mm	Repeatability
Max. Geschwindigkeit des Kolbens	1	m/sec.	Max. speed of the piston
Auslösezeit	≤ 0,1	ms	Switch of time
Einschaltzeit	≤ 2	ms	Switch on time
Elektrische Lebensdauer mit Widerstand	10 ⁷	N°	Electrical life with resistive load

Adapter
CNOMO-Zylinder

Bestell-Nr.	Ø	Y	W
33.009.08	32 - 63	25	
33.009.09	80 - 200	25	

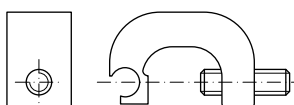

Fastening Clamps
CNOMO Cylinders

Order No.	Ø	Y	W
33.009.08	32 - 63	25	
33.009.09	80 - 200	25	

