

The following page(s) are extracted from multi-page Kuhnke product catalogues or CDRoms and any page number shown is relevant to the original document. The PDF sheets here may have been combined to provide technical information about the specific product(s) you have selected.

Hard copy product catalogues, and CDRoms have been published describing Kuhnke Pneumatics, Solenoids, Relays and Electronics; some divided into different books. A list of current publications is available on this web site or from our sales offices. Some may be available for download, but as substantially larger files.

Contact Details

Kuhnke sales and service in North America

Kuhnke
Automation Inc.
P.O Box 1369
Wayne, N.J.

T: (973) 633 0690
F: (973) 633 7230
Email: sales@kuhnkeusa.com

Important Note

The information shown in these documents is for guidance only. No liability is accepted for any errors or omissions. The designer or user is solely responsible for the safe and proper application of the parts, assemblies or equipment described.

Fittings and Misc. Accessories

Series 50,52,56 Fittings

Kuhnke System Logic Devices

Miniature Metric Brass Fittings

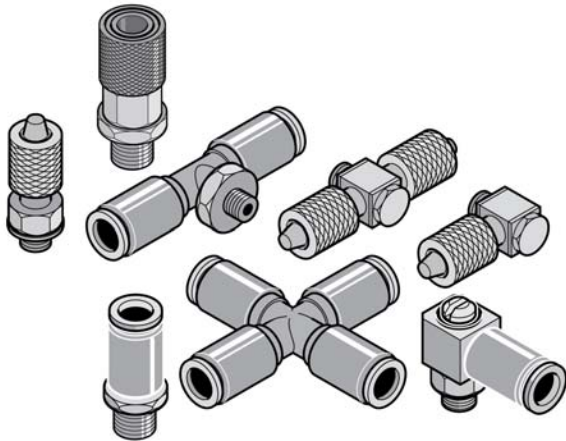

Series 50

Brass metric sized fittings provide a full family of connectors for most applications in miniature pneumatics. Machined from solid brass stock, fittings are dependable, easy to install and reduce space requirements.

Series 50 fittings also include quick connect couplings and brass manifolds.

Series 52, 56

Instant push-in fittings provide a fast means of connecting pneumatic systems. Air connections are made by pushing tubing into fitting. Removal of tubing is done by pressing in on the brass collar, releasing tube. Series 52 fittings are designed for 5/32 inch (4mm) tubing and are constructed with a brass base and an anodized aluminum collar. Series 56 push-in fittings are constructed the same except have molded collars, and accept 1/8 inch (6mm) tubing.

Technical Specifications

Operating Pressure;

0-175 PSI or vacuum.

Material:

Series 50 – Brass

Series 52 – Brass, anodized aluminum sleeve.

Series 56 – Brass, Polyamide sleeve.

Port/Thread:

M5, G 1/8, G 1/4 Metric

Port Washers:

Nylon or Buna N

Type of tubing:

Fittings accept most non-rigid nylon or plastic (polyamide) tubes. See specific fittings for wall thickness limitations.

Miniature Metric Brass Fittings

Tube Coupling

M5 for 5 x 1 mm tubing **50007**

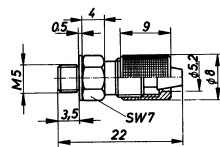

Tube Coupling

M5 for 6 x 1 mm tubing **50021**

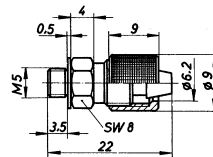

Tube Coupling

G 1/8 for 5 x 1 mm tubing **50008**

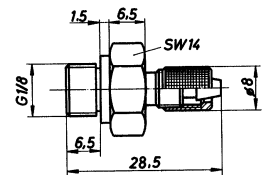

Tube Coupling

G 1/8 for 6 x 1 mm tubing **50046**

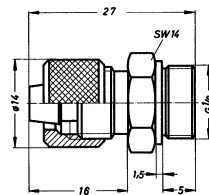

L – Banjo

M5 for 5 x 1 mm tubing **50130**

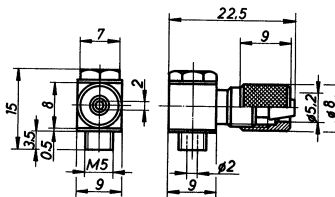

L – Banjo

M5 for 6 x 1 mm tubing **50191**

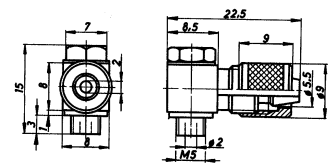

T – Banjo

M5 for 5 x 1 mm tubing **50140**
M5 for 6 x 1 mm tubing **50192**

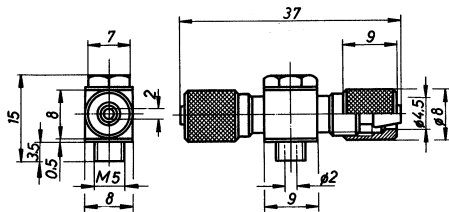

L – Banjo

M5 for 5 x 1 mm tubing **50170**

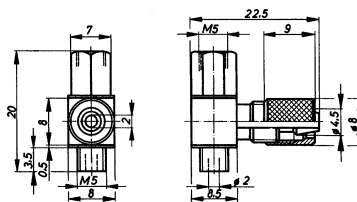

T – Banjo

M5 for 5 x 1 mm tubing **50180**

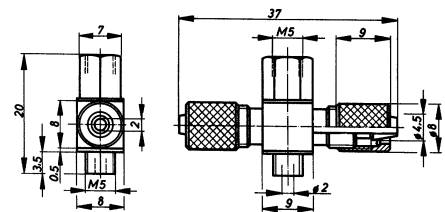

All dimensions in millimeters.

Male metric threads do not fit 10-32 NPT ports without damaging threads. Female M5 ports accept either M5 or 10-32 NPT male fittings.

Fittings with G1/8 male threads fit both Metric and NPT ports.

Fittings and Misc. Accessories

Series 50 Fittings

Kuhnke System Logic Devices

Miniature Metric Brass Fittings

L – Swivel

50400 5 x 1 Tubing
50420 6 x 1 Tubing
 M5 movable swivel screw fitting for slow turning movements.

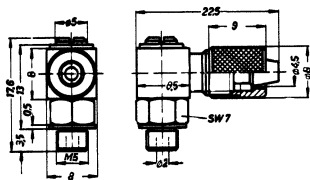

T – Swivel

50410 5 x 1 Tubing
 M5 movable swivel screw fitting for slow turning movements.

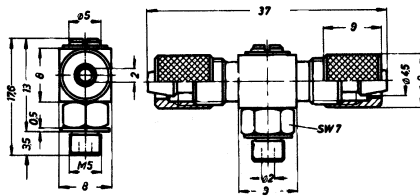

Bulkhead Coupling

50056 5 x 1 Tubing

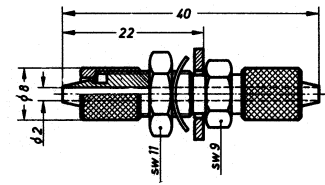

Tube Nipple (Polyamide)

50704 M5 for 3 mm I.D. Tubing
50706 M5 for 2 mm I.D. Tubing

Max. Tightening torque 1.5 lbs. Self sealing thread. Temperature range -10° C to + 40° C.

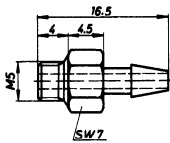

Tube Nipple

50036 M5 for 2 mm I.D. Tubing

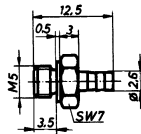

Tube Nipple

50040 M5 for 2 mm I.D. PVC type Tubing

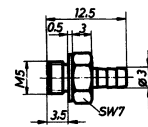

L – Banjo

50121 M5 with hex head
50150 M5 with screw head

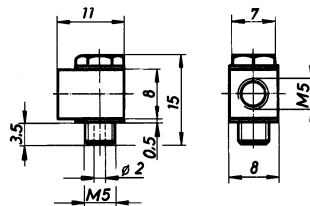

T – Banjo

50123 M5 with Hex head

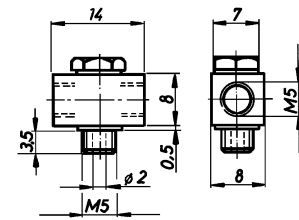

Tube Coupling (Female)

50045 M5 for 2 mm I. D. Tubing

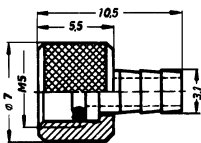

All dimensions in millimeters.

Male metric threads do not fit 10-32 NPT ports without damaging threads. Female M5 ports accept either M5 or 10-32 NPT male fittings. Fittings with G1/8 male threads fit both Metric and NPT ports.

Miniature Metric Brass Fittings

Reducing Nipple

G 1/8 to M5 **50052**

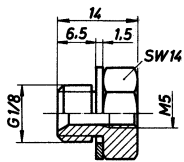

Reducing Nipple

G 1/4 to M5 **50054**

G 1/4 to G 1/8 **50627**

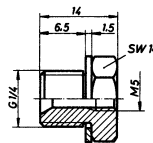

Coupling

Male to Female M5 **50051**

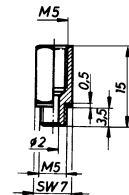

Coupling Sleeve

Female to Female M5 **50009**

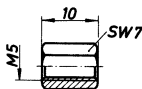

Reducing Sleeve

Female G1/8 to M5 **50053**

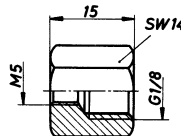

Double Nipple

Male to Male M5 **50050**

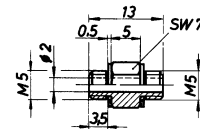

Port Plug

M5 **50500**

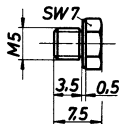

Port Plug

G 1/8 **50501**

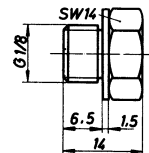

Double Nipple

M5 with locknut **50100**

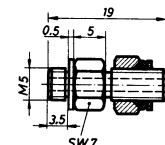

All dimensions in millimeters.

Male metric threads do not fit 10-32 NPT ports without damaging threads. Female M5 ports accept either M5 or 10-32 NPT male fittings. Fittings with G1/8 male threads fit both Metric and NPT ports.

Miniature Metric Brass Fittings

L – Manifold

50120 M5

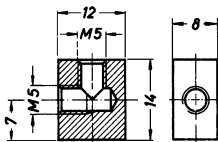

T – Manifold

50122 M5

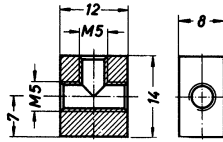

X – Manifold

50124 M5

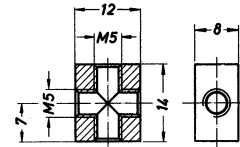

Manifold

50222 6 output
Two G 1/8 inputs to six M5 outputs.

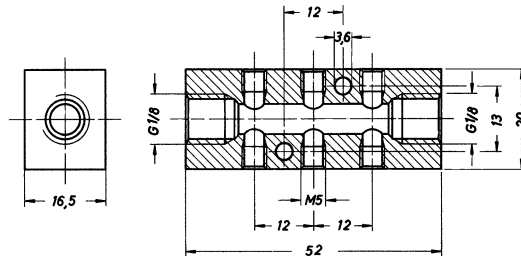

Manifold

50224 10 output
Two G 1/8 inputs to ten M5 outputs.

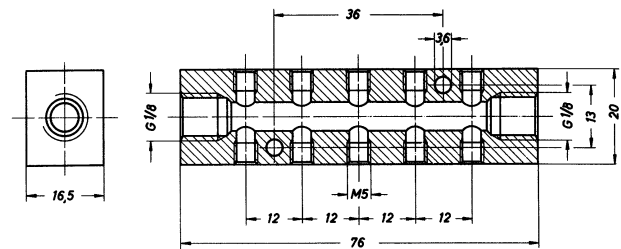

All dimensions in millimeters.

Male metric threads do not fit 10-32 NPT ports without damaging threads. Female M5 ports accept either M5 or 10-32 NPT male fittings.

Fittings with G1/8 male threads fit both Metric and NPT ports.