

The following page(s) are extracted from multi-page Kuhnke product catalogues or CDRoms and any page number shown is relevant to the original document. The PDF sheets here may have been combined to provide technical information about the specific product(s) you have selected.

Hard copy product catalogues, and CDRoms have been published describing Kuhnke Pneumatics, Solenoids, Relays and Electronics; some divided into different books. A list of current publications is available on this web site or from our sales offices. Some may be available for download, but as substantially larger files.

## Contact Details

Kuhnke sales and service in North America

Kuhnke  
Automation Inc.  
P.O Box 1369  
Wayne, N.J.

T: (973) 633 0690  
F: (973) 633 7230  
Email: [sales@kuhnkeusa.com](mailto:sales@kuhnkeusa.com)

### Important Note

The information shown in these documents is for guidance only. No liability is accepted for any errors or omissions. The designer or user is solely responsible for the safe and proper application of the parts, assemblies or equipment described.

---

# Miniature Valves

## Series 79, 81, 84 Spool Valves

Kuhnke Miniature Valves

### Steel Spool Valves, Mechanically and Manually Operated

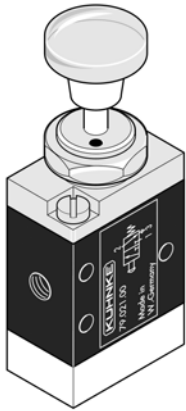

3 Way PB  
Series 79

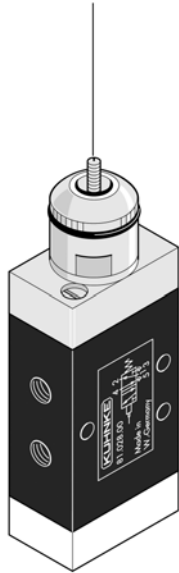

Series 81  
Cat  
Whisker

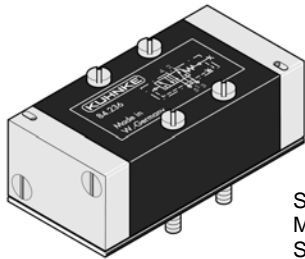

Sub base  
Mounted  
Series 84

Series 79, 81 and 84 mechanically operated spool valves are constructed of precision lapped steel spools and sleeves. Series 79 is a 3 way valve; Series 81 is a 4 way (5 ported) valve, and Series 84 is a manifold mounted 4 way valve. These valves are fitted with a wide variety of operators including pushbuttons, lever operators, cat whiskers, ball and plungers, in addition to several special application types.

Several valve designs use an air piloted assist mechanism to allow for very low actuation forces.

All valves can be mounted via through body holes, and most valves can be nose mounted (through panel) or on accessory brackets.

### Technical Specifications

#### Flow in Bars and Liters per Minute

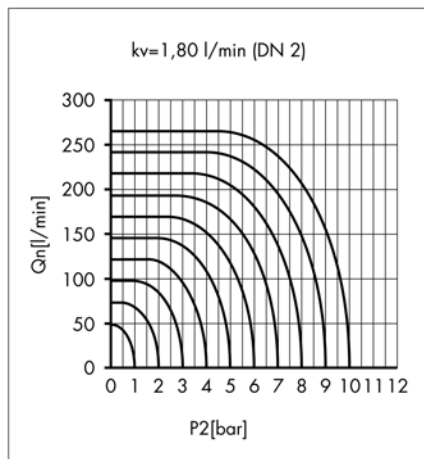

(1 Bar = 14.5 PSI; 1 Liter = .03531 cubic feet)

#### Operating Pressure:

0 to 145 PSI  
Air assist types:  
30 to 145 PSI

#### Vacuum:

Not applicable.

#### Flow Rate:

7 CFM @ 100 PSI  
3 CFM @ 45 PSI

#### Cv/Kv:

Cv - 0.12  
Kv - 1.8

#### Orifice:

2mm

#### Connection:

10-32 or M5 ports

#### Media:

Filtered Air

#### Actuation:

Force depends on  
model. Spring return

#### Materials:

Aluminum housing, hardened steel  
spool and sleeve, Buna N seals,  
makrolon or zinc end caps.

#### Average Mechanical Life:

100 million operations

#### Operating Ambient:

-10° C to 70° C (12° F to 160° F)

#### Operation:

For air piloted assist versions,  
supply pressure must be  
connected to port 1.

#### Dimensions - Valve Body (inches) :

	3 Way Valve	4 Way Valve
Height:	1 1/2	2
Width:	5/8	5/8
Depth:	1	1

#### Mounting:

(3) 1/8" through body holes or nose  
mounted. See individual valve types.

**79020**  
Plunger Operated  
3 Way

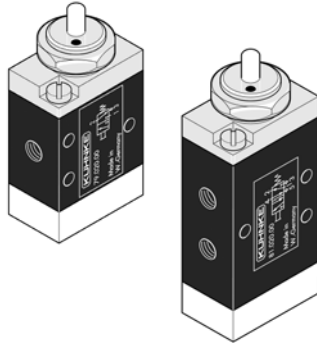
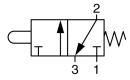

**81020**  
Plunger Operated  
4 Way

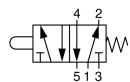

Valve is operated by pressure on plunger. Travel approx. 1/8" for actuation, spring return. Plunger dia. is 3/16", force required – 1 3/4 lbs. Used as end of travel detector or door closed button. Can be panel or bracket mounted in 1/2" dia. hole. Dimension above valve body is 17/32". Weight 2.3 ozs.

**79022**  
Roller Lever  
3 Way

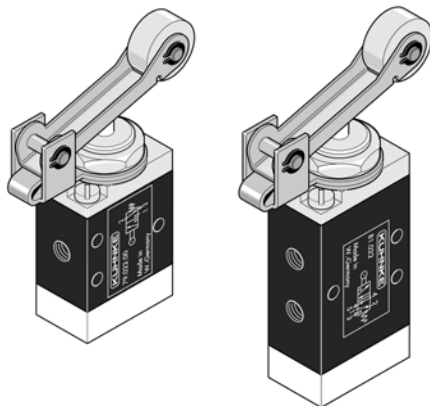
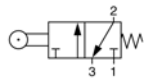

**81022**  
Roller Lever  
4 Way

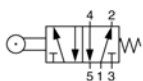

Used as a pneumatic limit switch or position detector. Actuator travel 3/8" for valve operation. Actuation force approx. 14 ozs. Can be bracket mounted in 1/2" dia. hole. Dimension above valve body is 1 3/16". Max. lever travel is 1/2". Weight 2.7 ozs.

**79021**  
Pushbutton  
3 Way

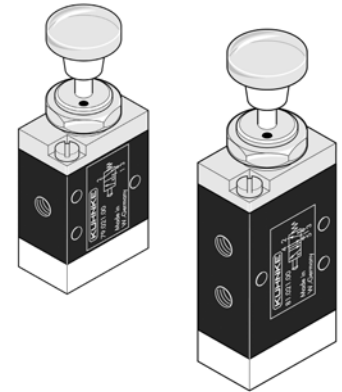
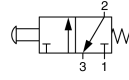

**81021**  
Pushbutton  
4 Way



Valve is operated by a small pushbutton. Travel approx. 1/8" for actuation. Momentary (spring return) action. Pushbutton dia. 5/8", force 1 3/4 lbs. Good for general purpose momentary air pressure switching. Can be panel mounted in 1/2" dia. hole. Dimension above valve body is 7/8". Weight 2.4 ozs.

**79023**  
One Way  
Roller Lever  
3 Way

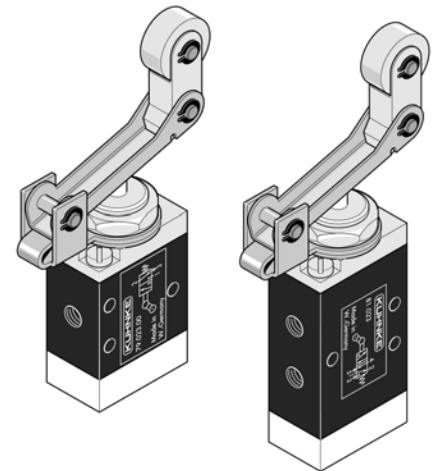
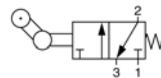

**81023**  
One Way  
Roller Lever  
4 Way

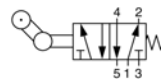

Roller lever operates valve only in one direction. Can be used as safety valve for limiting travel on machinery. Actuator travel and force same as roller lever (opposite). Dim. above valve body is 1 13/16". Max. lever travel is 1/2". In non actuate position roller moves down 5/16". Can be bracket mounted in 1/2" dia. hole. Weight 2.9 ozs.

# Miniature Valves

## Series 79, 81, 84 Spool Valves

Kuhnke Miniature Valves

**79027**  
Plunger  
Air Pilot Assist  
3 Way

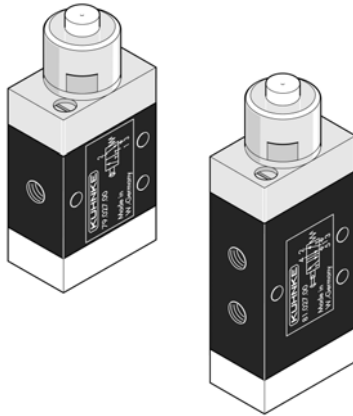
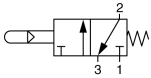

**81027**  
Plunger  
Air Pilot Assist  
4 Way

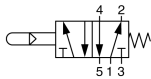

Valve is actuated by light pressure on plunger. Travel less than 1/16" for actuation. Ideal for detecting small parts. Air consumption - .07 CFM, switching time - 65 ms (at 90 PSI). Actuation force is 0.9 oz. Dimension above valve body is 19/32". Weight 2.2 ozs.

**79029**  
Ball Operator  
Air Pilot Assist  
3 Way

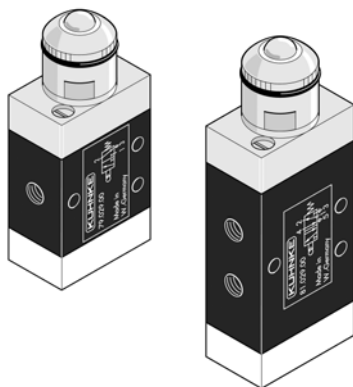
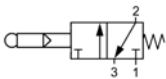

**81029**  
Ball Operator  
Air Pilot Assist  
4 Way

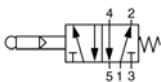

Valve is actuated by pressure on ball bearing. Travel approx. 3/64" for actuation. Ball rolls with mass as it moves by. Force required to actuate valve is 0.9 oz. Can be used for detecting items on conveyor systems. Air consumption - .07 CFM, switching time - 65 ms (at 90 PSI). Dimension above valve body is 3/4". Weight 2.4 ozs.

**79028**  
Cat Whisker  
Air Pilot Assist  
3 Way

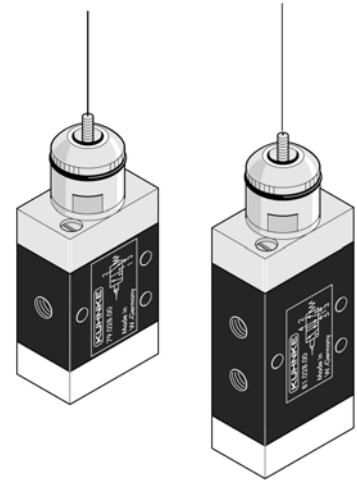
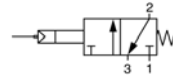

**81028**  
Cat Whisker  
Air Pilot Assist  
4 Way

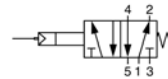

Actuation caused by deflection of fine spring supported wire. Allows valve to be mounted close to detected unit and provides wiping action. Wire can be bent at top up to 3/8" for specific application. Air consumption - .07 CFM, switching time - 65 ms (at 90 PSI). Actuation force is .02 oz. Dimension above valve body is 2 11/16". Weight 2.4 ozs

**79017-03**  
Valve for Oil-Tight  
Pushbuttons  
3 Way

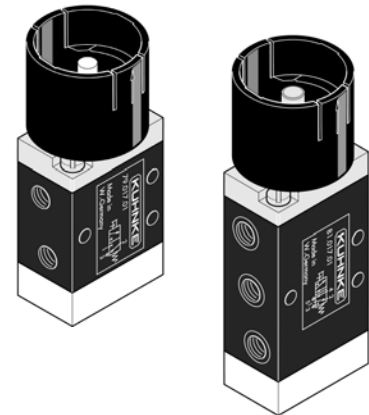
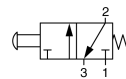

**81017-03**  
Valve for Oil-Tight  
Pushbuttons  
4 Way

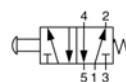

Valve is designed for use with standard miniature size (7/8" dia.) pushbutton operators. Enables pneumatic switching to be combined with electromechanical switching on control consoles. Fits *Moeller* operators, see accessories. Weight (valve only): 2 .5 ozs.

Approximate valve body dimensions are 1.5" L (3 way), 2" L (4 way) x 1" H x 5/8" W. Through body mounting holes (3) are 1/8" dia.  
**See accessories for brackets and renewal parts. For detail dimensions contact factory.**

**79024**  
Amplifier  
3 Way

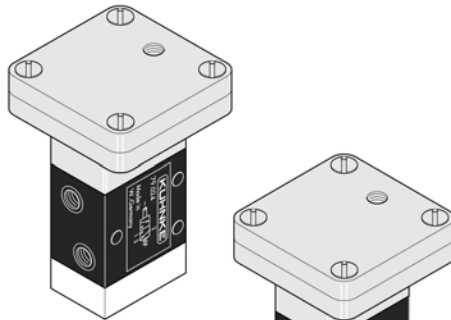
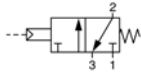

**81024**  
**84215** (Manifold Mtd.)  
Amplifier  
4 Way

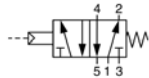

Amplifiers can be used to switch line pressure valves from a low pilot pressure signal. A pressure signal applied to the control port operates valve. Pilot signal range - .075 - 1.5 PSI (5 - 100 mbar). Valve operating pressure - 30 to 115 PSI. Weight 3.1 ozs.

**79036**  
Pulse Shaper  
3 Way

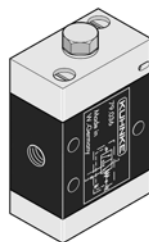
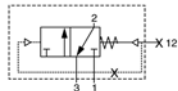

**84236** (Manifold Mtd.)  
Pulse Shaper  
4 Way

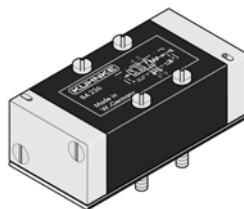
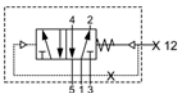

The pulse shaper converts a continuous signal into a pulse signal. Ideal for providing count pulses to pneumatic counters or electronic pressure transducers. Can be applied in parallel with working device circuits that have a long on cycle. Operating pressure range is 45 -145 PSI. Duration of pulse - 80-140 Ms @ 115 PSI.

**79026**  
Air Jet Detector  
Fixed Nozzle  
3 Way

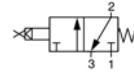

**81026**  
Air Jet Detector  
Fixed Nozzle  
4 Way

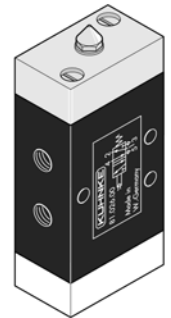
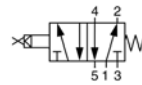

Air jet detectors are used for contact sensing of parts and tools. Can be used with delicate components. A stream of air is sent from a nozzle. As an object touches off the nozzle, the stream is blocked causing back pressure and operating the valve. Air consumption - .07 CFM @ 90 PSI. Switching time @ 90 PSI - 65 ms. Weight 2.1 ozs.

**79025**  
Air Jet Detector  
Flexible Nozzle  
3 Way

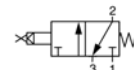

**81025**  
Air Jet Detector  
Flexible Nozzle  
4 Way

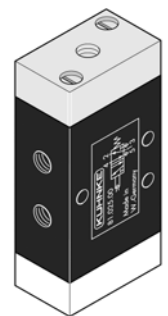
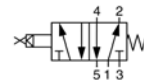

Same as air jet detector above, except used with flexible hose and nozzle. Any length of hose can be used, however, length of tube (volume) determines valve switch over time. Can be used for detecting objects in tight areas. See accessories for hose kit cat. no. 43138. Weight 2 ozs.

For manifolds and sub bases used with valves 84215 or 84236 see accessories for miniature solenoid valves. Approximate valve body dimensions are 1.5" L (3 way), 2" L (4 way) x 1" H x 5/8" W. Through body mounting holes (3) are 1/8" dia. **See accessories for brackets and renewal parts. For detail dimensions contact factory.**